

# CAP High School Prize Exam

10 March 2011  
9:00 - 12:00

## Competitor's Information Sheet

The following information will be used to inform competitors and schools of the exam results, to determine eligibility for some subsequent competitions, and for statistical purposes. Only the marking code, to be assigned by the local examination committee, will be used to identify papers for marking.

Marking Code:

This box must be left empty.

### PLEASE PRINT CLEARLY IN BLOCK LETTERS

Family Name: \_\_\_\_\_ Given Name: \_\_\_\_\_

Home Address: \_\_\_\_\_

\_\_\_\_\_ Postal Code: \_\_\_\_\_

Telephone: (     ) \_\_\_\_\_ Email: \_\_\_\_\_

School: \_\_\_\_\_ Grade: \_\_\_\_\_

Physics Teacher: \_\_\_\_\_

Date of Birth: \_\_\_\_\_ Sex:   Male    Female

Citizenship: \_\_\_\_\_ or

Immigration Status: \_\_\_\_\_

For how many years have you studied in a Canadian school? \_\_\_\_\_

Would you prefer the further correspondence in French or English? \_\_\_\_\_

Sponsored by:

Canadian Association of Physicists,  
Canadian Physics Olympiad,  
University of British Columbia,  
Department of Physics and Astronomy.

## Canadian Association of Physicists 2011 Prize Exam

This is a three-hour exam. National ranking and prizes will be based on students performance on sections A and B of the exam. Performance on the questions in parts A will be used to determine whose written work in part B will be marked for prize consideration by the CAP Exam National Committee. Part A consists of twenty-three multiple-choice questions. The questions in part B span a range of difficulties, and may require graphing. Be careful to gather as many of the easier marks as possible before venturing into more difficult territory. If an answer to part (a) of a question is needed for part (b), and you are not able to solve part (a), assume a likely solution and attempt the rest of the question anyway.

Non-programmable calculators may be used. Please be careful to answer the multiple-choice questions **on the answer card/sheet** provided; most importantly, write your solutions to the three long problems on **three separate** sheets as they will be marked by people in different parts of Canada. Good luck.

**Notice:** Full marks will be given to a student who provides any full correct solution to the long problems. Partial marks will be given for partial solutions. There are no penalties for incorrect answers. The questions are not of equal difficulty. Remember we are challenging the best physics students in Canada; it is possible that even the best papers may not achieve an overall score of 80%. This is meant to be tough!

### Data

Speed of light  $c = 3.00 \times 10^8$  m/s  
 Gravitational constant  $G = 6.67 \times 10^{-11}$  Nm<sup>2</sup>/kg<sup>2</sup>  
 Acceleration due to gravity  $g = 9.80$  m/s<sup>2</sup>  
 Density of fresh water  $\rho = 1.00 \times 10^3$  kg/m<sup>3</sup>  
 The normal atmospheric pressure  $P_0 = 1.01 \times 10^5$  Pa  
 The specific heat of water  $c = 4.186 \times 10^3$  J/kgK  
 Fundamental charge  $e = 1.60 \times 10^{-19}$  C  
 Mass of electron  $m_e = 9.11 \times 10^{-31}$  kg  
 Mass of proton  $m_p = 1.67 \times 10^{-27}$  kg  
 Planck's constant  $h = 6.63 \times 10^{-34}$  Js  
 Coulomb's constant  $1/(4\pi\epsilon_0) = 8.99 \times 10^9$  Nm<sup>2</sup>/C<sup>2</sup>  
 Boltzmann's constant  $k = 1.38 \times 10^{-23}$  J/K  
 A.U. Astronomical Unit =  $1.49598 \times 10^{11}$  m The approximate distance from the Sun to the Earth.  
 Radius of the Earth =  $6.371 \times 10^6$  m  
 Linear expansion coefficient of iron  
 $\alpha_{Fe} = 1.1 \times 10^{-5}$  K<sup>-1</sup>  
 Linear expansion coefficient of zinc  
 $\alpha_{Zn} = 3.0 \times 10^{-5}$  K<sup>-1</sup>  
 1 US mile = 1609 meters  
 1 US gallon = 3.785 liters

### Part A: Multiple Choice

#### Question 1

Incandescent light bulbs are notorious for being relatively inefficient in producing visible light. The tungsten wire inside such a bulb is at a temperature of

approximately 3000 K and the emission spectrum is very similar to that of a blackbody. The efficiency is so low because

- Most of the electrons are absorbed in the tungsten wire.
- Most of the power is lost due to the resistance of the bulb.
- The electric power actually is efficiently transformed into radiation but at 3000 K, most of it is infrared.
- A blackbody absorbs more light than it emits, hence it appears black.

#### Question 2

A solar panel installed on a spaceship has a maximum energy output of 5 kW near the Earth. What is the maximum energy output of the solar panel when the spaceship is near Mars? (The distance from the Earth to the Sun is 1 A.U. and from Mars to the Sun is 1.5 A.U.)

- 3.3 kW;
- 2.2 kW;
- 1.0 kW;
- 0.55 kW;
- 0.20 kW.

#### Question 3

A scientist measured a  $1\mu A$  current in an area of a human brain. Unlike current in metals which is carried by free electrons, the current in the brain is mainly carried by potassium ions. Each potassium ion has one unit of charge  $e$ . This current corresponds to the flow of how many potassium ions per second?

- $6 \times 10^5$ ;
- $6 \times 10^6$ ;
- $6 \times 10^8$ ;
- $6 \times 10^{12}$ ;
- $6 \times 10^{18}$ .

#### Question 4

The gas supply to your physics professor's house suddenly stops due to a gas line failure. It is winter and the temperature outside is  $-5^\circ C$  and constant. Assuming all the doors and windows remain closed, which of these graphs best describes how the temperature in the house changes with time after the gas supply stops?

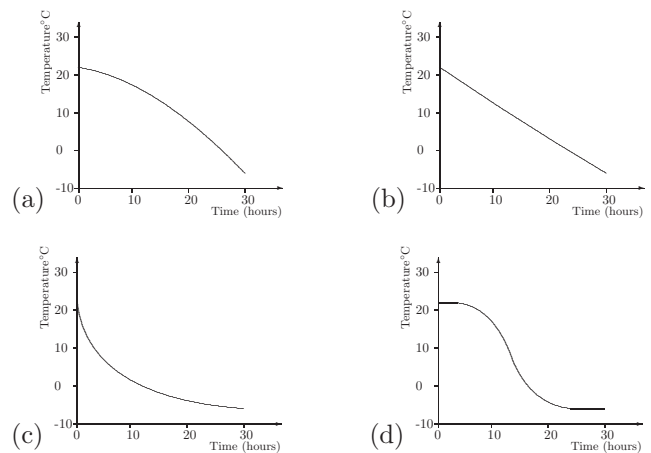

**Question 5**

The ray of light travelling in air hits the parallel glass plate as shown. Which are the possible continuations of the light ray?

- a) 4 only.
- b) both 2 and 4.
- c) both 3 and 6.
- d) both 1 and 5.

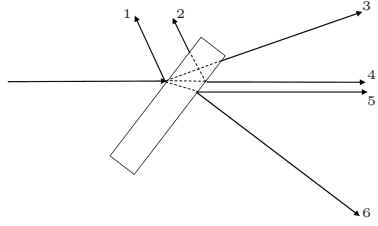

**Question 6**

Approximately, what fraction of the energy emitted by the Sun reaches to the Earth?

- (a)  $10^{-7}$ ; (b)  $10^{-10}$ ; (c)  $10^{-13}$ ; (d)  $10^{-16}$ .

**Question 7**

The resistance of the tungsten in a light bulb increases with temperature. Which of the following graphs shows the current as a function of voltage for the light bulb?

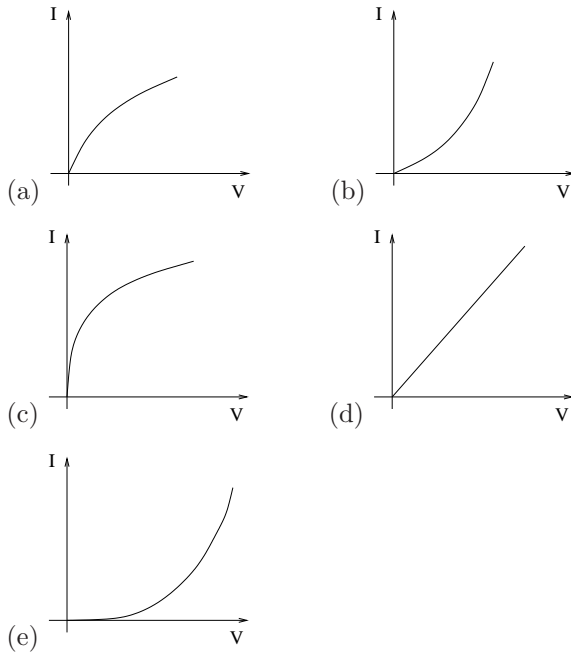

**Question 8**

A fast rocket travels directly upwards at  $0.5c$  (half the speed of light). There is an explosion directly below the rocket. If astronauts manage to measure how fast the light produced by the explosion is moving relative to their spacecraft, they will find the light to be moving:

- a) Upwards at speed  $0.5c$ .
- b) Upwards at speed  $c$ .
- c) Upwards at speed  $1.5c$ .
- d) Downwards at speed  $0.5c$ .
- e) Downwards at speed  $c$ .

**Question 9**

Two identical clocks are set to the same time as one passes the other at very high (relativistic) velocity

as shown in the top figure. Which of the other figures represents a possible observation of the clocks at some later time in the reference frame of the stationary clock?

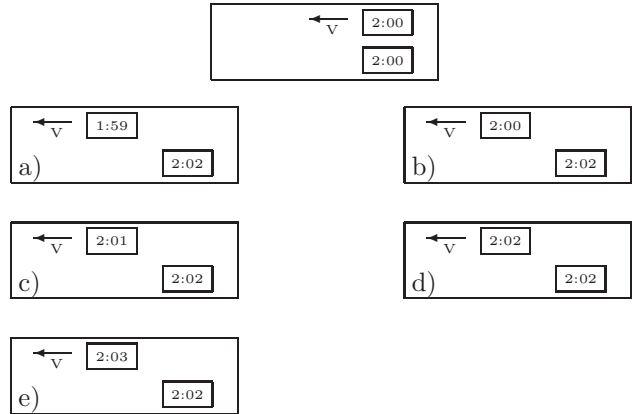

**Question 10**

For the statements:

- 1) Mass can be directly converted into kinetic energy.
- 2) Kinetic energy can be directly converted into mass.

- a) Only first is true.
- b) Only second is true.
- c) Both are true.
- d) Neither is true.

**Question 11**

A stable Helium-4 nucleus has two protons and two neutrons. If the mass of Helium-4 nucleus, proton and neutron are denoted by  $m_{\text{He}}$ ,  $m_p$  and  $m_n$  respectively, we can conclude that:

- a)  $m_{\text{He}} = 2m_p + 2m_n$ .
- b)  $m_{\text{He}} > 2m_p + 2m_n$ .
- c)  $m_{\text{He}} < 2m_p + 2m_n$ .
- d) Any of the above may be true.

**Question 12**

A clean metal surface is placed in a vacuum. The surface is irradiated with monochromatic light of variable intensity  $I$  (number of photons per unit area) and frequency  $f$ . We measure the maximum kinetic energy  $K$  of electrons emitted from the metal due to the photoelectric effect. How does  $K$  behave when  $I$  increases?

- a)  $K$  increases.
- b)  $K$  is constant.
- c)  $K$  decreases.
- d) Impossible to determine.

**Question 13**

A point mass is moving in the  $xy$  plane. Its acceleration is a constant vector perpendicular to the  $x$  axis, then:

- a) only  $v_y$  is constant.
- b) only  $v_x$  is constant.
- c) only the acceleration is constant.
- d) the acceleration and  $v_x$  are constant.
- e) the position and  $a_y$  are constant.

**Question 14**

A huge case, attached to a cable, is descending at a constant velocity. The tension in the cable is (neglecting the air resistance):

- a) greater than the weight of the case.
- b) smaller than the weight of the case.
- c) equal to the weight of the case.
- d) we cannot tell since we dont know the weight of the case.

**Question 15**

Objects A and B, isolated from the environment, are initially separated from each other and are then placed in thermal contact. Their initial temperatures are  $T_A = 0^\circ\text{C}$  and  $T_B = 100^\circ\text{C}$ . The heat capacity of B is twice the one of A. After a certain time, the system reaches equilibrium. The final temperatures are:

- a)  $T_A = T_B = 50^\circ\text{C}$ .
- b)  $T_A = T_B > 50^\circ\text{C}$ .
- c)  $T_A = T_B < 50^\circ\text{C}$ .
- d)  $T_A > T_B > 50^\circ\text{C}$ .
- e)  $T_A > 50^\circ\text{C} > T_B$ .

|                   |                     |
|-------------------|---------------------|
| A                 | B                   |
| 1.0Kg             | 2.0Kg               |
| $0^\circ\text{C}$ | $100^\circ\text{C}$ |

**Question 16**

When a car is starting, its driving wheels experience:

- a) The force of kinetic friction directed backward.
- b) The force of static friction directed backward.
- c) The force of kinetic friction directed forward.
- d) The force of static friction directed forward.

**Question 17**

An aquarium partly filled with water accelerates down an incline which is at an angle  $\theta$  with respect to the horizon. The surface of water in the aquarium:

- a) is horizontal.
- b) is parallel to the plane of the incline.
- c) forms an angle  $\alpha$  with the horizon, where  $0^\circ < \alpha < \theta$
- d) forms an angle  $\alpha$  with horizon, where  $\theta < \alpha < 90^\circ$ .

**Question 18**

Objects around us have different colours. This is because

- a) They are at different temperatures.
- b) They are non-thermal radiation sources.
- c) Different materials or paints reflect light at different speeds.
- d) Different materials or paints reflect different wavelengths.

**Question 19**

This graph shows the average temperature inside a room. At time  $t_1$  the heater is turned on. We want to compare the power input to the room ( $P_{in}$ ) and the power output from the room ( $P_{out}$ ). For which region(s) on the graph is  $P_{in} \neq P_{out}$ ?

- a) Only region I.
- b) Only region II.
- c) Only region III.
- d) Only regions I & III.
- e) Regions I, II & III.

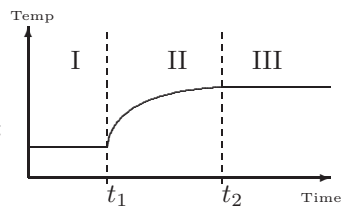

**Question 20**

A spherical asteroid with a radius of 1 km is illuminated by sunlight. In order to calculate the solar power absorbed by the asteroid, what area should be used?

- a)  $1 \text{ km}^2$ .
- b)  $3.14 \text{ km}^2$ .
- c)  $12.6 \text{ km}^2$ .
- d) Answer cannot be determined from the available data.

**Question 21**

If you toss a ball up, at the highest point

- a) The velocity changes direction.
- b) The acceleration changes direction.
- c) The acceleration is zero.
- d) Both velocity and acceleration are zero.
- e) More than one of the above is correct.

**Question 22**

Many cars are now equipped with anti-lock brakes (ABS), which prevents locking of the wheels during emergency braking. What is the main advantage?

- a) This saves the tires. Otherwise too much rubber is left on the road.
- b) Provides more control over the car but stopping distance increases slightly.
- c) This leads to a shorter stopping distance because tires exert rolling friction which is larger than kinetic friction.
- d) This leads to a shorter stopping distance because tires exert rolling friction which is larger than static friction.
- e) This leads to a shorter stopping distance because tires exert static friction which is larger than kinetic friction.

**Question 23**

Rank in order, from brightest to dimmest, the identical bulbs A to D.

- a)  $A = B = C = D$ .
- b)  $A = B > C = D$ .
- c)  $A > C > B > D$ .
- d)  $A > C = D > B$ .
- e)  $C = D > B = A$ .

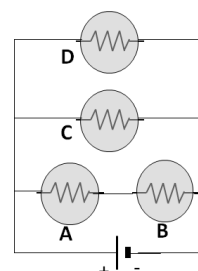

## Part B: Problems

### Problem 1

Last year, a customer tried to compare two cars. A manufacturer of the USA car claims fuel efficiency of 30 mpg (miles per gallon). The manufacturer of the European car states the fuel efficiency of 7.81/100km (liters per hundred kilometers).

(a) Which car is more efficient and by how much?

This year, still undecided, this customer noticed that both manufacturers improved their fuel efficiency numbers by 20%.

(b) Which car is more efficient now, and by how much?

Fig. 1 shows the velocity as a function of time graph for a trip you took with your car.

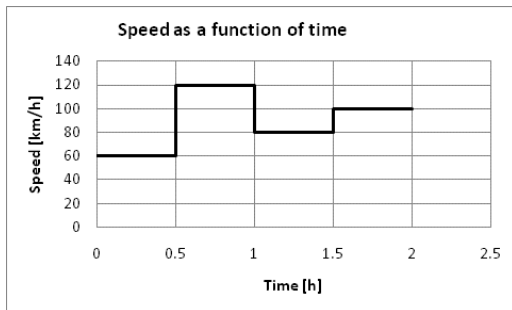

Figure 1

(c) Determine the total distance travelled during this two hour trip.

(d) Fig. 2 displays the air drag force as a function of velocity. What is the total work done by the drag force on the car during this two hour trip?

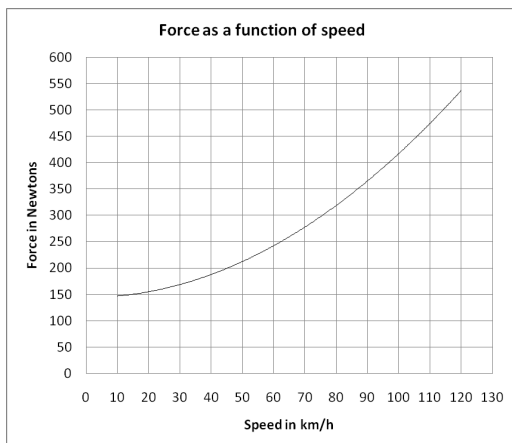

Figure 2

(e) Each liter of gasoline has 35 MJ of energy. The efficiency of the motor as a function of the car's speed is shown on Fig. 3. How much gasoline is used to overcome the air drag during this two hour trip?

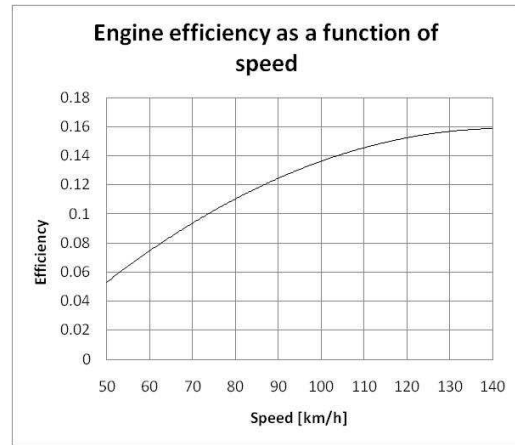

Figure 3

(f) In which part of the trip the fuel was used most efficiently (least gasoline used per kilometer travelled)?

### Problem 2

Photo A shows a pendulum for a grandfather clock. It consists of very thin sets of iron and zinc rods and the pendulum bob. At room temperature there is one iron rod of length  $L_{0\text{Fe}} = 68.00$  cm, two iron rods of length  $L_{1\text{Fe}}$  and two zinc rods of length  $L_{\text{Zn}}$  connected as in diagram B. Both sets of rods are of negligible weight compared to the pendulum bob. The thickness of the connecting pieces is negligible compared to the length of the rods. The bob is attached to the iron rod. The pendulum length, then is  $L = L_{0\text{Fe}} + (L_{1\text{Fe}} - L_{\text{Zn}})$ ,  $L = 70.00$  cm.

(a) Does the position of the rods in diagram B correspond to a warmer day or a colder day compared to their position in diagram C?

(b) Find  $L_{1\text{Fe}}$  and  $L_{\text{Zn}}$  if the pendulum period does not change when the temperature changes.

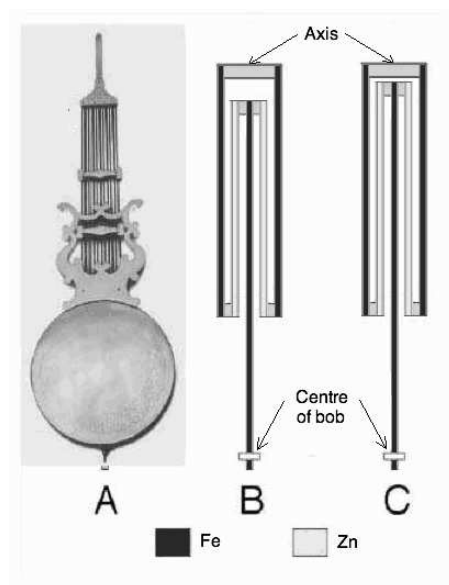

**Problem 3**

Two radio antennas are 100 m apart on a north-south line. They broadcast identical radio waves at a frequency of 3.0 MHz. Your job is to monitor the signal strength with a handheld receiver. To get to your first measuring point, you walk 800 m east from the midpoint between the antennas, then 600 m north.

- (a) What is the phase difference between the waves at this point?
- (b) Is the interference at this point maximally constructive, perfectly destructive, or somewhere in between? Explain.
- (c) If you now begin to walk further north, does the signal strength increase, decrease, or stay the same? Sketch the amplitude of the signal as a function of the distance.